



# CATÁLOGO 2026

## Camión Frigorífico



**faycom**  
[www.faycom.es](http://www.faycom.es)

FABRICACIÓN Y COMERCIALIZACIÓN DE SISTEMAS Y  
SUS COMPONENTES DE ILUMINACIÓN, SEÑALIZACIÓN  
Y SEGURIDAD, PARA TODO TIPO DE VEHICULO DE  
SERVICIOS, INDUSTRIALES, AGRÍCOLAS Y  
COMERCIALES, RECOGIENDO CADA UNA DE  
SUS NECESIDADES.

NOS INSPIRAMOS EN TUS NECESIDADES  
PARA ESTABLECER NUESTROS COMPROMISOS

# Luces estroboscópicas | Strobe lights



LED  
12/24 V

26 secuencias

● **FA410005**  
9W, 3 LED x 3W

106 x 30 x 34 mm



LED  
9/30 V

26 secuencias

● **FA101442**  
9W, 3 LED x 3W

80 x 19 x 28 mm



LED  
12/24 V

26 secuencias

● **FA410006**  
12W, 4 LED x 3W

132 x 30 x 34 mm



LED  
9/30 V

26 secuencias

● **FA101445**  
12W, 4 LED x 3W

96 x 19 x 28 mm



LED  
12/24 V

26 secuencias

● **FA410036**  
24W, 6LED x 4W



**FLEXIBLE**  
117 x 27 x 12 mm



LED  
12/24 V

26 secuencias

● **FA410010A**  
20W, 4 LED x 5W

110 x 36 x 17 mm



LED  
12/24 V

26 secuencias

● **FA410012A**  
30W, 6 LED x 5W

130 x 36 x 17 mm



LED  
12/24 V

26 secuencias

● **FA410015A**  
60W, 12 LED x 5W

120 x 52 x 14 mm



LED  
12/24 V

26 secuencias

● **FA410013A**  
60W, 12 LED x 5W

130 x 54 x 17 mm



LED  
9/30 V

26 secuencias

● **FA101448**  
18W, 6 LED x 3W

128 x 19 x 28 mm

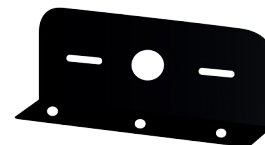

115 x 63 x 20 mm  
**FA410001**  
Soporte corto

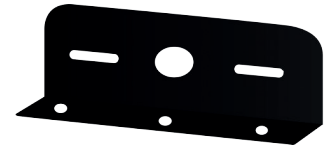

142 x 63 x 20 mm  
**FA410002**  
Soporte largo



LED  
10/30V

**IP67**  
10 secuencias

● **FA410038**  
134 x 40 x 12 mm  
Posición delantera y estroboscópica



LED  
10/30 V

**IP67**  
10 secuencias

● **FA410037**  
134 x 40 x 12 mm  
Posición trasera y estroboscópica



## Rotativos y destellantes R65 R10 | R65 R10 Flash-Beacons



LED  
12/24 V

- 1. Rotativo
- 2. Flash
- 3. Flash doble
- 4. Flash cuádruple

Con selector 4 secuencias R65

Altura total 68 mm  
Ø 140 mm (base)

### ● FA101326LED-R65

Base 3 tornillos | 12W, 12 LED x 1W



LED  
12/24 V

- 1. Rotativo
- 2. Flash
- 3. Flash doble
- 4. Flash cuádruple

Con selector 4 secuencias R65

Altura total 122 mm  
Ø 140 mm (base)

### ● FA101280LED-R65

Base 3 tornillos | 12W, 12 LED x 1W



LED  
12/24 V

Destellante

Altura total 46 mm  
Ø 112 mm (base)

### ● FA520005-A

Base 3 tornillos y magnético | 27W, 18 LED x 1,5W

Con interruptor en enchufe mechero



LED  
12/24 V

Destellante

Altura total 70 mm  
Ø 85 mm Ø 112 mm (base)

### ● FA101240LED-R65

Base 3 tornillos | 27W, 18 LED x 1,5W



## Faros de trabajo y marcha atrás | Worklights



LED  
10/30 V

IP68

231 x 54 x 46 mm

### ● FA503312

Faro Marcha Atrás e iluminación lateral y trasera  
1.600 lumens | 18W, 18 LED x 1W Homologado R-23



LED  
10/30 V

Con interruptor

IP69K

90 x 90 x 45 mm

### ○ FA503302LED

Faro de Marcha Atrás y trabajo  
850 lumens | 12W, 12 LED x 1W Con cable 2 m.



LED  
10/30 V



IP67

157 x 51 x 44 mm

### ○ FA503171

2.500 lumens | 30W/24W  
Faro de trabajo y marcha atrás con estroboscópica



LED  
10/30 V

### ○ FA503151

Faro de trabajo  
2.300 lumens | 22W



LED  
10/80 V

Carretillos y varios

IP67

Con interruptor

125 x 95 x 50 mm

### ● FA503187

Faro de trabajo  
2.880 lumens | 26W, 26LED x 1W

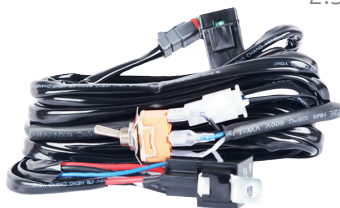

### ● FA604001 12/24 V

Instalación para iluminación  
Con interruptor con 1 salida y relés



### ● FA604002 12/24 V

Instalación para iluminación  
Con interruptor con 2 salidas y relés









 EMC R10 approval <b>LED</b> 10/30 V	 EMC R10 approval <b>LED</b> 12/24 V	 EMC R10 approval <b>LED</b> 12/24 V
IP67 124 x 124 x 13 mm <b>FA503257</b> 500 lumens   4 LED	IP67 Ø 177 x 16 mm <b>FA210401</b> 780 lumens   39 LED (SMD)	IP67 Ø 155 x 16 mm <b>FA210400</b> 420 lumens   21 LED (SMD)

 Ø 155 mm <b>FA210402</b> Aro embellecedor	 Ø 177 mm <b>FA210403</b> Aro embellecedor	 Ø 155 mm <b>FA210143</b> Aro para empotrar
--	--	---

 EMC R10 approval <b>LED</b> 10/30 V	 EMC R10 approval <b>LED</b> 10/80 V
IP67 Ø 70 mm <b>FA503261</b> Plafón luz Blanca y Azul penumbra con sensor táctil	IP67 200x120 mm <b>FA503262</b> Plafón luz Blanca y Azul penumbra con sensor táctil

 EMC R10 approval <b>LED</b> 10/30 V	 EMC R10 approval <b>LED</b> 10/30 V
IP67 Ø130 x 20 mm <b>FA503274</b> Sin interruptor	IP67 Ø130 x 20 mm <b>FA503275</b> Con interruptor táctil

 EMC R10 approval <b>LED</b> 10/30 V	 EMC R10 approval <b>LED</b> 10/30 V
IP67 Ø130 x 12 mm <b>FA503276</b> Sin interruptor	IP67 Ø130 x 12 mm <b>FA503277</b> Con sensor movimiento

# Luces interiores | Interior lights



LED  
10/30 V



LED  
12/24 V



IP67

Ø76 x 13 mm

115 x 40 x 19 mm

**FA503263**

Sin interruptor

**FA210420**

Luz cajón | Con interruptor



LED  
10/30 V



LED  
10/30 V



IP67

136 x 66 x 19 mm

IP67

136 x 66 x 19 mm

**FA503264**

Sin interruptor

**FA503265**

Con interruptor táctil



LED  
10/30 V



LED  
10/30 V



IP67

200 x 60 x 34 mm

IP67

200 x 60 x 34 mm

**FA503266**

Sin interruptor, con inclinación de 45°

**FA503267**

Con sensor táctil, con inclinación de 45°



LED  
10/30 V



LED  
10/30 V



IP67

300 x 54 x 12 mm

IP67

600 x 54 x 12 mm

**FA503268** Sin interruptor

**FA503270** Con interruptor táctil

**FA503272** Con sensor movimiento

**FA503269** Sin interruptor

**FA503271** Con interruptor táctil

**FA503273** Con sensor movimiento



LED  
9/80 V



LED  
9/80 V



IP67

245 x 25 x 16 mm

IP67

400 x 25 x 16 mm

**FA210404**

200 lumens | 9 LED (SMD) | Con interruptor

**FA210405**

600 lumens | 18 LED (SMD) | Con interruptor





IP67

**FA510005**

470 x 28 x 13.5 mm

Con interruptor lateral

LED  
10/30 V



IP67

**FA510006**

570 x 28 x 13.5 mm

Con interruptor lateral

LED  
10/30 V



IP67

**FA510007**

870 x 28 x 13.5 mm

Con interruptor lateral

LED  
10/30 V



IP67

**FA510008**

Sensor movimiento independiente

110 x 50 x 222 mm



IP67

**FA510009**

Plafón con regulador y 3 modos de luz

300 x 118 x 29 mm

LED  
10/30 V



**FA606040**

Interruptor



## KIT FRIGORÍFICO

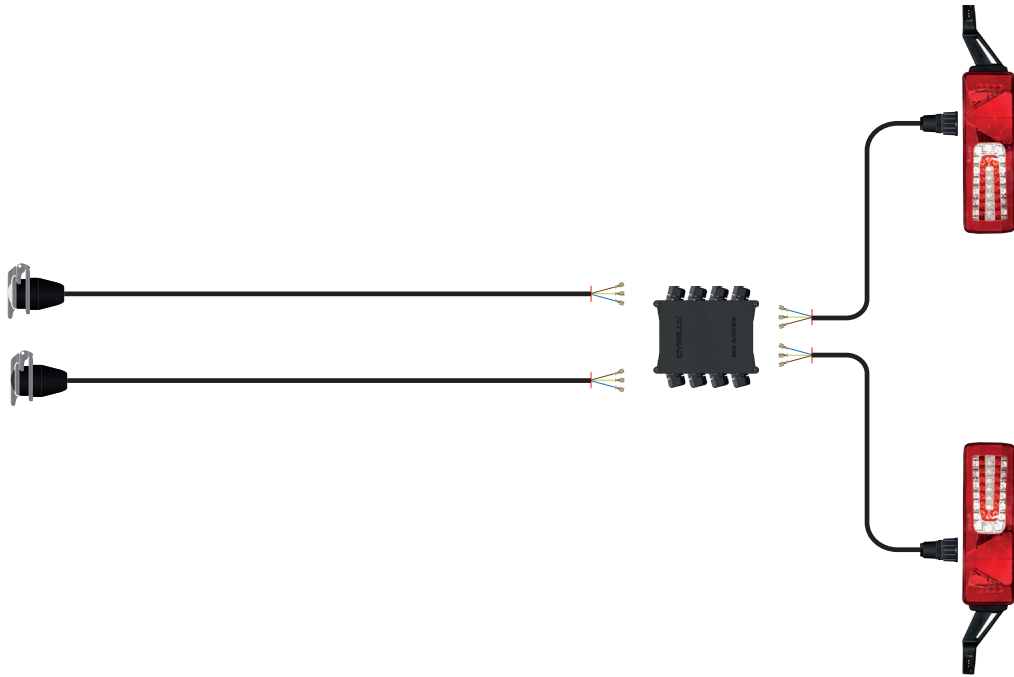

**FA105416**

Instalación completa

## KIT SHAPELINE PLATAFORMA Y FRIGORÍFICO

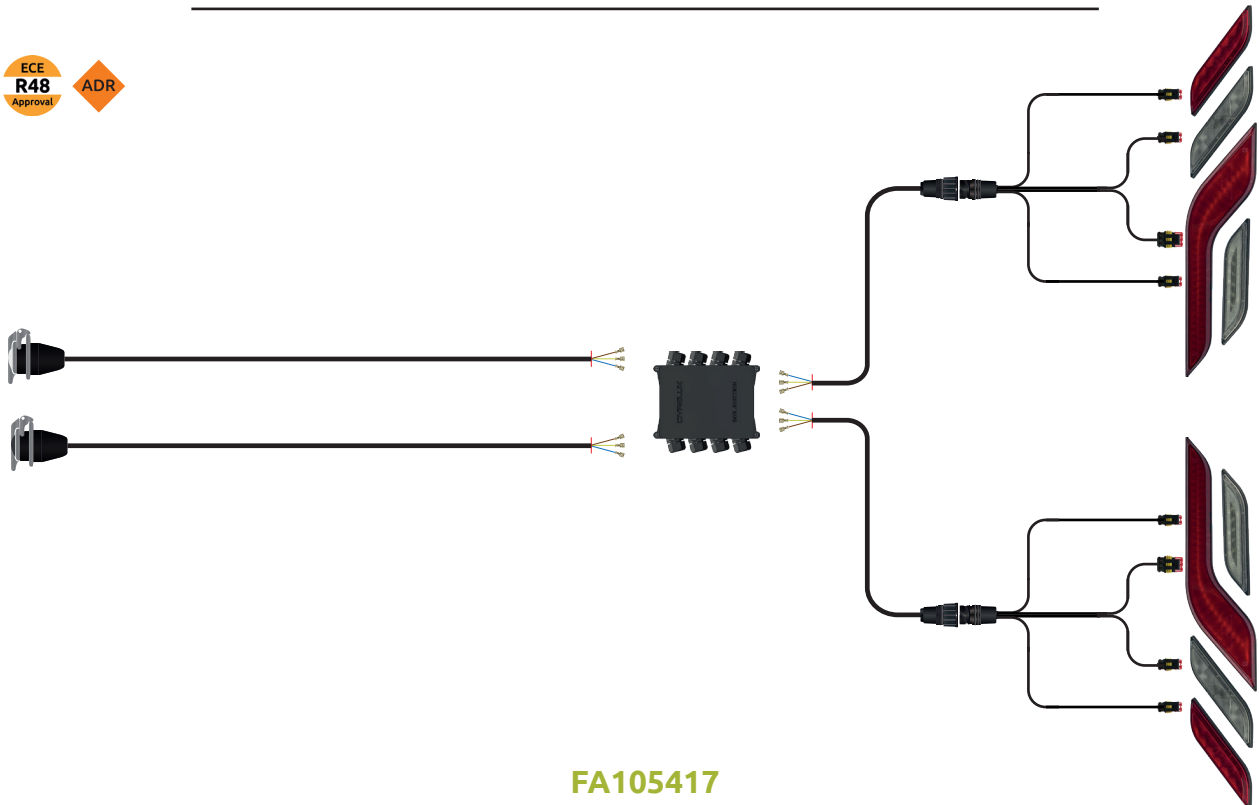

**FA105417**

Instalación completa





### KIT RENOVE PILOTOS TRASEROS 3+3 UNIVERSAL



LED  
24 V



#### FA101427

Kit instalación completa luces traseras.

### KIT RENOVE PILOTOS TRASEROS 2+2 UNIVERSAL - SCHMITZ



LED  
24 V



#### FA101428

Kit instalación completa luces traseras.

### KIT RENOVE PILOTOS TRASEROS 3+3 UNIVERSAL - SCHMITZ



LED  
24 V



#### FA101424

Kit instalación completa luces traseras.

**KIT RENOVE PILOTO TRASERO CON CONECTOR ESTANCO Y GUARDAPOLVO**



 Intermitente **Dinámico**  **LED**  
 24 V

IP69K



**FA326076** Izd.  
**FA326077** Dch.

**KIT RENOVE PILOTO TRASERO CON CONECTOR ESTANCO, GUARDAPOLVO Y CUERNO ANCHURA**

**OE PRODUCT** 

 Intermitente **Dinámico**  **LED**  
 24 V

IP69K



**FA326151** Izd.  
**FA326152** Dch.

**KIT RENOVE BLACK PILOTO TRASERO CON CONECTOR ESTANCO Y GUARDAPOLVO**

**OE PRODUCT** 

 **Glowing**  **LED**  
 Intermitente **Dinámico** 24 V

IP69K

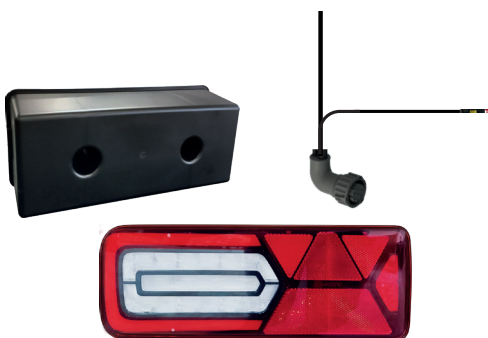

**FA326166** Izd.  
**FA326167** Dch.

**KIT RENOVE BLACK PILOTO TRASERO CON CONECTOR ESTANCO, GUARDAPOLVO Y CUERNO ANCHURA**

**OE PRODUCT** 

 **Glowing**  **LED**  
 Intermitente **Dinámico** 24 V

IP69K



**FA326168** Izd.  
**FA326169** Dch.





### KIT RENOVE LUCES SUPERIORES DE CAJA Y FRIGORÍFICOS



LED  
24 V

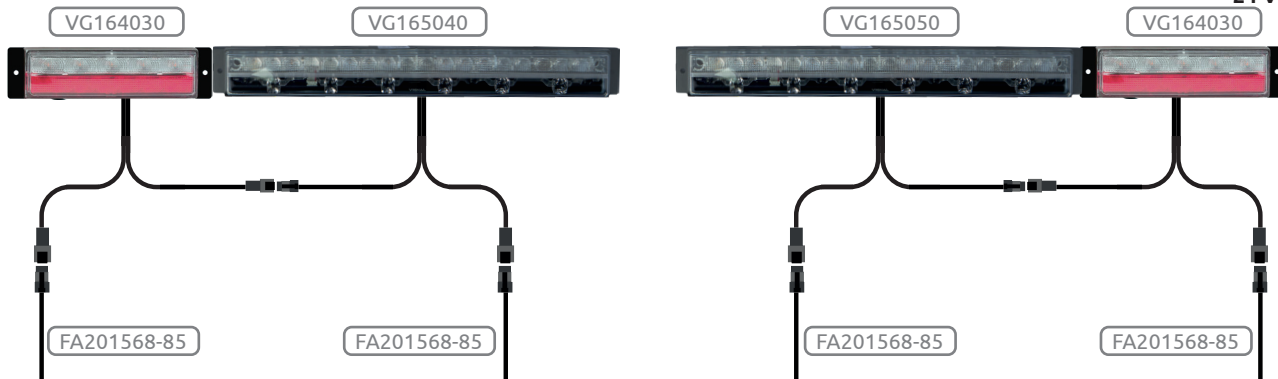

#### FA101426

Kit instalación completa luces traseras, con posición, freno, intermitente dinámico, luz emergencia y faro de trabajo.

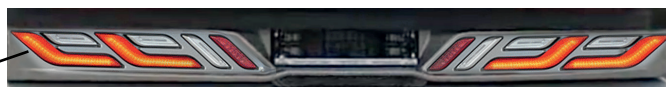

### KIT RENOVE INSTALACIÓN SHAPELINE 4+4



LED  
9/32 V

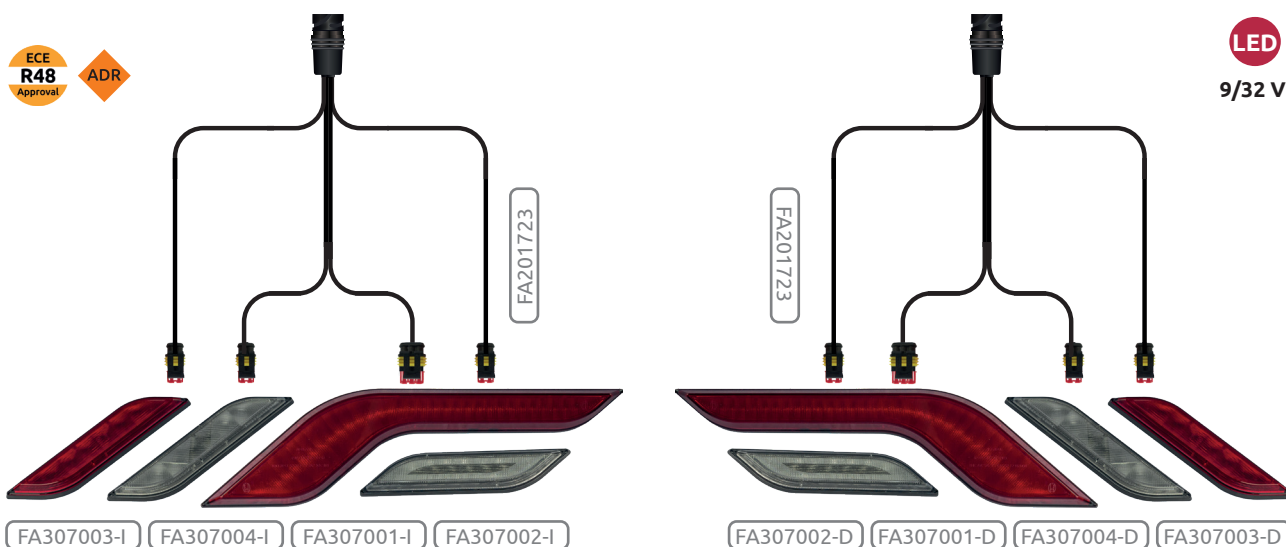

#### FA101425

Kit instalación completa luces traseras, con posición, freno, intermitente dinámico, marcha atrás y antiniebla.

**UNIVERSAL**

**LED**

9/32 V

**SHAPELINE**  
DESIGN YOUR LIGHT



Consulta configuraciones

**NUEVO PILOTO TRASERO MODULAR  
SHAPELINE**

**OE PRODUCT**



**FA307001-I** Izd.  
**FA307001-D** Dch.  
Posición y freno.

**OE PRODUCT**



**FA307002-I** Izd.  
**FA307002-D** Dch.  
Intermitente dinámico.

**OE PRODUCT**

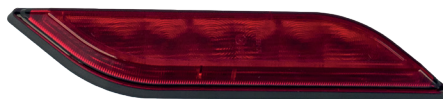

**FA307003-I** Izd.  
**FA307003-D** Dch.  
Antiniebla.

**OE PRODUCT**



**FA307004-I** Izd.  
**FA307004-D** Dch.  
Marcha atrás.



**FA102723**  
Cableado



AMP 1,5  
**FA501521**  
Kit Clavija 7 vías



**FA201532**  
Kit Conector 2 vías  
Conector macho  
Pins hembra



**FA201534**  
Kit Conector 3 vías  
Conector macho  
Pins hembra



**LUCES SUPERIORES TRAILER FRIGORÍFICOS Y CON CAJA - UNIVERSAL**



**OE PRODUCT**

Intermitente **Dinámico**

**LED**

24 V

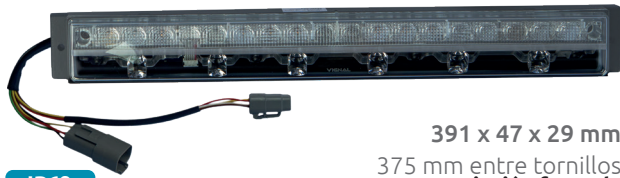

391 x 47 x 29 mm  
375 mm entre tornillos  
**Sujeción frontal**

**IP69**

**VG165040** Izd. Con pestañas  
**VG165050** Dch. Con pestañas

Intermitente, luz de emergencia y faro de trabajo

**OE PRODUCT**

Intermitente **Dinámico**

**CHEREAU**

**LED**

24 V



365 x 47 x 29 mm  
340 mm entre tornillos  
**Sujeción trasera**

**IP69**

**VG165020** Izd. Sin pestañas  
**VG165030** Dch. Sin pestañas

Intermitente, luz de emergencia y faro de trabajo

**OE PRODUCT**

Intermitente **Dinámico**

**LED**

24 V

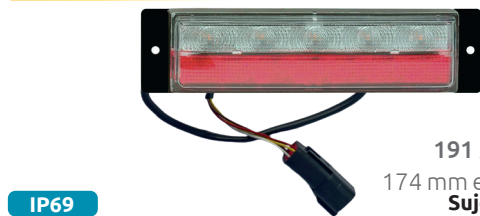

191 x 47 x 29 mm  
174 mm entre tornillos  
**Sujeción frontal**

**IP69**

**VG164020** 1 Conector Con pestañas

Posición, freno, intermitente y luz de emergencia

**OE PRODUCT**

Intermitente **Dinámico**

**CHEREAU**

**LED**

24 V



165 x 47 x 29 mm  
150 mm entre tornillos  
**Sujeción trasera**

**IP69**

**VG164000** 1 Conector Sin pestañas

Posición, freno, intermitente y luz de emergencia

**OE PRODUCT**

Intermitente **Dinámico**

**LED**

24 V



191 x 47 x 29 mm  
174 mm entre tornillos  
**Sujeción frontal**

**IP69**

**VG164030** 2 Conectores Con pestañas

Posición, freno, intermitente y luz de emergencia

**OE PRODUCT**

Intermitente **Dinámico**

**CHEREAU**

**LED**

24 V



165 x 47 x 29 mm  
150 mm entre tornillos  
**Sujeción trasera**

**IP69**

**VG164010** 2 Conectores Sin pestañas

Posición, freno, intermitente y luz de emergencia



**FA201568**

Kit Conector 4 vías DT  
Conector macho  
Pins hembra



**FA201568-85**

8,5 m.



**FA201567**

Kit Conector de 4 vías DTM  
Conector hembra  
Pins macho



**FA201592**

Kit Conector de 4 vías DTM  
Conector hembra,  
pins Macho



**FA201593**

Kit Conector de 4 vías DTM  
Conector macho  
Pins hembra



## Pilotos traseros | Rear lamps

### CHEREAU - UNIVERSAL



LED

10/30 V

IP67 Con cable

190 x 49 x 28mm  
174 mm entre tornillos

**FA210204**

Posición, freno e intermitente

### UNIVERSAL



LED

10/30 V

IP67 Con cable

190 x 49 x 28mm  
174 mm entre tornillos

**FA210210**

Posición, freno, intermitente y marcha atrás

### LAMBERET - UNIVERSAL

OE PRODUCT



LED

12/24 V

IP69K Con cable

120 x 39 x 16 mm  
108 mm entre tornillos

**FA326093** Posición, freno e intermitente

**FA326094** Antiniebla y marcha atrás

### UNIVERSAL



LED

10/30 V

IP67 Con cable

191 x 50 x 23 mm  
174 mm entre tornillos

**FA326095** Posición, freno, intermitente  
y marcha atrás

**FA326095-1** Posición, freno e intermitente

**FA326100** Antiniebla y marcha atrás

### UNIVERSAL



LED

12/24 V

IP67 Con cable

164 x 56 x 32 mm  
106 mm entre tornillos

**FA326022**

Posición, freno e intermitente



LED

12/24 V

IP67 Con cable

164 x 56 x 32 mm  
106 mm entre tornillos

**FA326026**

Posición, freno, intermitente y marcha atrás.

OE PRODUCT  
**Dyrelux**

Glowing

Intermitente Dinámico

LED

12/24 V



IP67



Ver P. 361  
**FA201568**

209 x 58 x 31 mm  
191 mm entre tornillos

**FA326115** Izd./Dch.

Posición, freno e intermitente





UNIVERSAL

LED

12/24 V



259 x 26 mm  
228 mm entre tornillos

**FA210536** Izd./Dch.

Posición y freno  
Cable 0,25 m

IP67

LED

12/24 V



259 x 26 mm  
228 mm entre tornillos

**FA210540** Izd./Dch.

Posición, freno e intermitente  
Cable 1 m

IP67

LED

12/24 V



259 x 26 mm  
228 mm entre tornillos

**FA210539** Izd./Dch.

Antiniebla  
Cable 0,25 m

IP67

LED

12/24 V



259 x 26 mm  
228 mm entre tornillos

**FA210537** Izd./Dch.

Intermitente  
Cable 0,25 m

IP67

LED

12/24 V



259 x 26 mm  
228 mm entre tornillos

**FA210538** Izd./Dch.

Marcha atrás  
Cable 0,25 m

IP67

LAMBERET - UNIVERSAL

OE PRODUCT

Intermitente Dinámico

LED

10/30 V



274 x 28 x 30 mm  
240 mm entre tornillos

**FA210545** Izd.

**FA210546** Dch.

Intermitente dinámico  
Cable 0,5 m

IP69K

OE PRODUCT

LED

10/30 V



274 x 28 x 30 mm  
240 mm entre tornillos

**FA210547** Izd./Dch.

Posición y freno  
Cable 0,5 m

IP69K

SERIE 250 UNIVERSAL

OE PRODUCT

jakon

LED

9/32 V

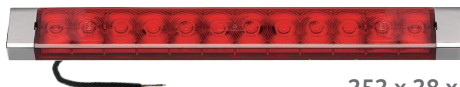

252 x 28 x 14 mm  
234 mm entre tornillos

**FA210530**

Posición y freno  
Cable 0,5 m

IP67

OE PRODUCT

jakon

LED

9/32 V



252 x 28 x 14 mm  
234 mm entre tornillos

**FA210532**

Marcha atrás  
Cable 0,5 m

IP67

**FA210531**

Intermitente  
Cable 0,5 m

KRONE

OE PRODUCT

jakon

LED

24 V



252 x 28 x 14 mm  
234 mm entre tornillos

**FA210533**

Catadióptrico

OE PRODUCT

IP67

**FA210136**

Translúcido rojo posición



INSTALACIONES TRASERAS



**FA102718**  
Instalación 2P.



**FA102719**  
Instalación 3P.



SCHMITZ

**FA102722-I** Izd.  
**FA102722-D** Dch.  
Instalación 2P.



SCHMITZ

**FA102721-I** Izd.  
**FA102721-D** Dch.  
Instalación 3P.



**FA201527-25**  
2,50 m.



**FA201568-85**  
8,5 m.

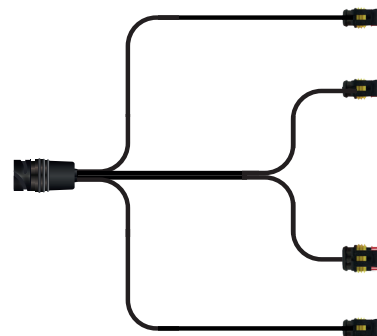

**FA102723**  
Cableado para pilotos Shapeline





## ADAPTADORES CONEXIÓN



**FA200866**

Adaptador cambio piloto

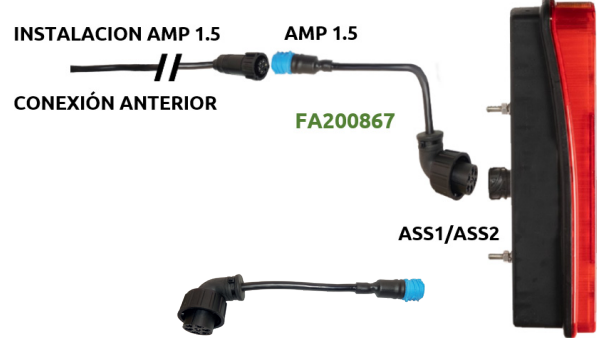

**FA200867**

**FA200867**

Adaptador cambio piloto

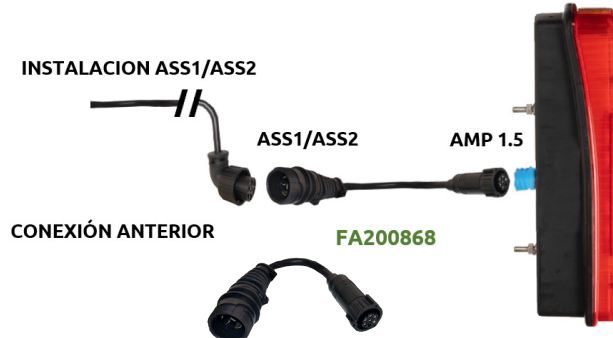

**FA200868**

**FA200868**

Adaptador cambio piloto

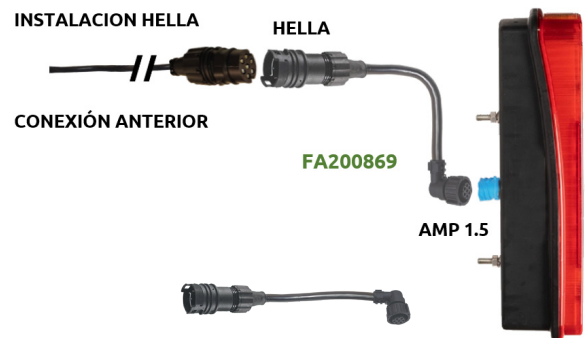

**FA200869**

**FA200869**

Adaptador cambio piloto

## ALARGADORES CONEXIÓN

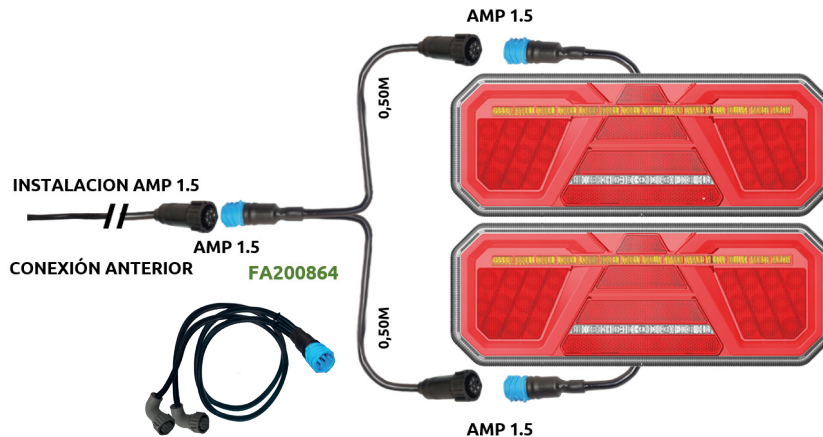

**FA200864**

Adaptador 2 pilotos 0,50m



**FA200870-15** Prolongador 1,5m

**FA200870-25** Prolongador 2,5m



# Adaptadores pilotos traseros | Rear lamp adapters

## ALARGADORES CONEXIÓN



**FA200871-15** Prolongador 1,5m  
**FA200871-25** Prolongador 2,5m



**FA200872-15** Prolongador 1,5m + 1m cable plano  
**FA200872-25** Prolongador 2,5m + 1m cable plano

## KIT ADAPTADOR CON ELECTRONICA PARA SISTEMA DE INTERMITENCIA

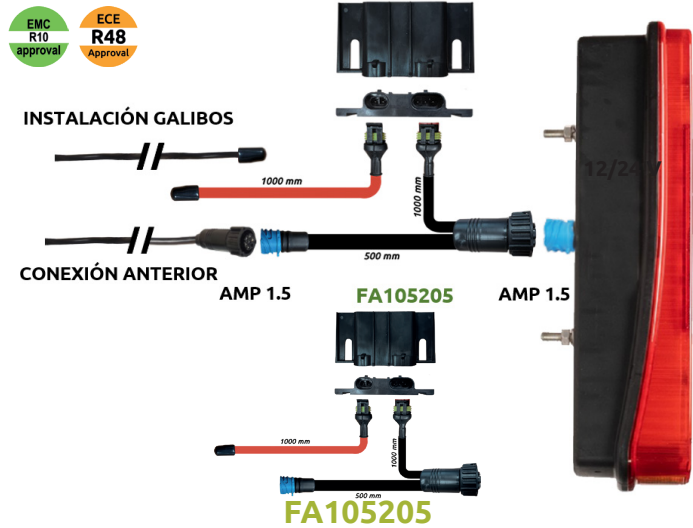

Kit instalación con electrónica parasistema intermitente ECE R-48  
Luces laterales de posición + Intermitente

# Cintas adhesivas reflectantes | Retro-reflective self-adhesive tapes

## SUPERFICIES RÍGIDAS V-23



**FA101191-A3M**  
Rollo de 50 m.



**FA101191-B3M**  
Rollo de 50 m.



**FA101191-R3M**  
Rollo de 50 m.

Camión Frigorífico





**faycom**  
[www.faycom.es](http://www.faycom.es)

FABRICACIÓN Y COMERCIALIZACIÓN DE SISTEMAS Y  
SUS COMPONENTES DE ILUMINACIÓN, SEÑALIZACIÓN  
Y SEGURIDAD, PARA TODO TIPO DE VEHICULO DE  
SERVICIOS, INDUSTRIALES, AGRÍCOLAS Y  
COMERCIALES, RECOGIENDO CADA UNA DE  
SUS NECESIDADES.

NOS INSPIRAMOS EN TUS NECESIDADES  
PARA ESTABLECER NUESTROS COMPROMISOS



**faycom**

Santo Domingo, 5 • Nave 9 • Polígono Centrovía

50198 • La Muela (Zaragoza)

+34 976 149 167

**[www.faycom.es](http://www.faycom.es)**

**[comercial@faycom.es](mailto:comercial@faycom.es)**